



Riddhi Engineering Company

www.couplings-mounts.com

sales@riddhiengineeringco.com

+91 74900 32784



FLEXIBLE DISC COUPLINGS FOR LOW & MIDDLE SPEED APPLICATION



The coupling series listed in this catalogue are applicable preferably to pumps, fans, compressors and other low & middle speed equipment driven by electromotors, internal combustion engines

无锡创明传动工程有限公司
WUXI TRUMY TRANSMISSION ENGINEERING CO.,LTD.









Brief introduction

Wuxi TRUMY Transmission Engineering Co., Ltd., former AVIC Num. 614 Research Institute Transmission Engineering Corporation, was founded in May 2001, has since then become a shareholding enterprise after system reforming. The corporation is engaged in research and development, manufacture, marketing and service of flexible couplings. TRUMY main products include: metallic flexible disc coupling, metallic flexible diaphragm coupling, grid coupling, among them metallic flexible laminated membrane coupling and metallic flexible diaphragm coupling were awarded second prize of science and technology progress by Ministry of Aviation Industry in 1990, accredited as one of the high-tech products of Jiangsu province in 1999.

Since the early 1980s the AVIC Num. 614 Research Institute has begun designing and application researching of metallic flexible couplings and formed a complete proprietary technology system. TRUMY carries on the proprietary technology of its predecessor, Num. 614 Research Institute, possesses sophisticated design computation technique and verification facilities, has accumulated a wealth of experience in product research & develop, design and application to processing power equipment and provided various solutions to flexible power transmitting sets for the industries.

TRUMY products passed ISO9001 quality system certification in 2003, GJB9001 quality system certification in 2007. The corporation has been accredited as a Hi-tech Enterprise of Jiangsu Province for consecutive years since 2003. Over 20 years TRUMY and its predecessor have built long term cooperative relationships with numerous well known processing power equipment manufacturers at home as well as abroad, supplied hundreds of thousands high quality coupling sets for industries.

CONTENT

D4&TD Series	Typical coupling design, first choice for most low & middle speed applications	
DJ4 & TDJ Series	Compact type couplings with the hub in a full or partial inversion form, applicable to short distance between shaft ends	
L Series	Couplings with link-form disc packs, easy to mount /dismount, can be partly substituted for TDJ series in low speed applications	
TDP Series	Couplings designed with one big and the other normal hubs, applicable to the shafts wide differing from each other in diameter.	
TDA Series	Couplings for low & middle speed applications to meet standards API 610 or API 671.	
TDP-T/TZ Series	Couplings with the coupling spacer of mild carbon steel or alloy-steel tube welding structure, suitable for applications of ultra distance between the shaft ends.	
D-X1 Series	Couplings suitable for corrosive atmosphere applications owing to their main parts made from stainless steel.	



Coupling series designation

TRUMY coupling designation consists of 5 groups as follows:

$$\frac{TD6-}{A} \quad \frac{370-}{B} \quad \frac{\frac{85 \times 100}{75 \times 100}}{C} \quad \frac{-120-00T1}{D} \quad E$$

Group A is composed of letters and figures, indicating coupling type and the number of holes in a disc respectively.

Figure notation 4 indicating 4 hole disc
 6 indicating 6 hole disc
 8 indicating 8 hole disc
 10 indicating 10 hole disc

Group B represents the grade of torque transmission or maximum external dimensions of the coupling (Larger numerical number means higher torque transmitted).

Group C shows the fitting diameter and length of driving and driven shaft ends (in a fraction form, with numerator representing driving shaft end, while denominator driven shaft end).

Group D specifies the distance between driving and driven shaft ends.

Group E shows design number of the coupling.

Guide to coupling selection

- ◆ The coupling series listed herein are mainly applicable to pumps, fans and compressors driven by electric motors or internal combustion engines, also to middle/low speed power transmission after the reductor driven by turbo-machinery. When applications are required to the equipment driven by steam turbines, gas turbines and various kinds of energy recovery turbo-machines, or to high/middle speed power transmission after the speed-increasing gear driven by electric motors or internal combustion engines, TRUMY high speed high performance flexible disc coupling series and high performance flexible diaphragm coupling series should be the first priority in selection. For some low speed applications TRUMY grid coupling series are also optional.
- ◆ Coupling series D4,TD and their derivatives should be preferential for oil refinery pumps, chemical industry pumps, low speed fans and other pumps driven directly by electric motors. If necessary for the coupling to be in accordance with API610, series TDA should be selected.
- ◆ When the shafts to be coupled are too close, the coupling should be selected from the compact type series such as DJ4,TDJ,LG according to the torque magnitude. If necessary, the single disc pack type with limited misalignment compensation may be selected for the situation.
- ◆ If the shafts to be coupled greatly differs from each other in diameter (big -small diameter ratio is over 1.4), the TDP series may be selected.
- ◆ For the case with extra -long distance between the shaft ends such as electric power station fans, mine fans, etc. series TDP-T/TZ should be selected.
- ◆ To the equipment working in the corrosive atmosphere (e. x. salt fog) such as cooling water tower fans the D-X1 series couplings are applicable.
- ◆ This catalogue is mainly compiled for common industry uses. For such special applications as test beds, production lines of various kinds or other specialized equipment customers may not always find suitable couplings from the catalogue. In this case please contact TRUMY sales engineer, the company will carry out special design to meet customer particular requirements.

Selection procedure

Whenever you have questions about coupling selection, please contact TRUMY sales engineer. Jointly selecting TRUMY couplings by both supply and demand sides is recommended.

1. According to driving and driven machines and operation conditions, select a service factor K from the table below.
2. Determine coupling calculation power rating P_c : $P_c = P \times K$
 where: P_c -- calculation power (Kw); P -- transmitting power (Kw). Taking into account that the driven machine may work under overload conditions, suggest that P is calculated according to the power value of the driving machine; K -- service factor.
3. Calculate transmitting torque of the coupling $T = 9549 \times P_c / n$
 where, T -- torque (N.m) ; n -- rated or normal working speed (r/min) .
4. Following the guide to coupling selection ,tentatively select coupling type according to the conditions $T \leq$ continuous torque rating and $n_{max} \leq$ max. speed.
5. Check the operating conditions
 - ◆ Check up peak torque and max. transient torque with the requirements of the machines. For the machines starting frequently and those with big start-up shock the starting torque should be checked. For the machines equipped with brake apparatus the braking torque should be checked. If specified, for power generation packages or machines driven by synchronous motors the transient

torque associated with generator short torque or the cyclic torque associated with synchronous motor start-up should be checked. If necessary, select the types with higher parameter values or select other coupling series.

- ◆ Check up the coupling type selected with the requirement for max. allowable shaft diameter. If necessary, select the types with higher parameter values or select other coupling series.
- ◆ Check up the distance between shaft ends (DBSE) with the requirement for min. DBSE of the coupling type selected. Appropriate DBSE enables not only the coupling to realize better performances but also the machines to be easily maintained. If required, DBSE should be in accordance with API610 or API671.
- ◆ Check up the capacity to accommodate axial displacement and angular misalignment of the coupling selected with requirements of the machines. If necessary, select the types with higher parameter values or select other coupling series. For the machines with larger thermal expansion the coupling may be processed by cold pre-stretching so that the coupling works in a small deformation state when the machines are thermally balanced in operation.

Service factors

Duty	Driven machine	Driving machine		
		electromotor, steam or gas turbines	Steam engine or water turbine	Internal combustion engine
Constant torque	Centrifugal pumps, light conveyors, alternators, light fans	1. 0*	1. 5	3. 0
Slight torque fluctuations	Machine tools, screw compressor, screw pumps, liquid ring compressors, rotary dryers	1. 5	2. 0	3. 5
Substantial torque fluctuations	Reciprocating pumps, low viscosity mixers, cranes, winches	2. 0	2. 5	4. 0
Exceptionally high torque fluctuations	Rotary presses, reciprocating compressors, high viscosity mixers, marine propellers	3. 0	3. 5	5. 0

- ◆ For the gear box the value of the factor 1.25 may be adopted, for direct electromotor start-up --- 1.5, according to the requirements in API671 the minimum is 1.5. When needed, the service factor value may be increased or decreased, following the relative rules in API671.
- ◆ If the customer can not find the corresponding types of driving or driven machines recommended in the table, please select the service factors from AGMA 514.02 or consult TRUMY sales engineer.

D4 series

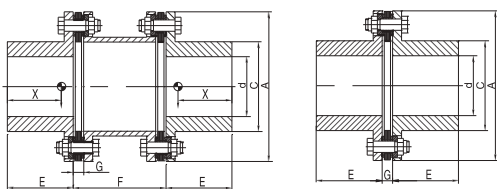

Single disc pack structure⁽⁵⁾



- ◆ Suitable for middle/low speed, low torque applications; for higher torque TD series should be selected.
- ◆ Four hole membrane disc; big capacity to compensate misalignments.
- ◆ Simple structure, easy mounting/dismounting.
- ◆ Widely applicable to industry processing pumps and small-scale fan sets.

Direction for use

1. Bore diameter d, hub outside diameter C, hub length E, distance between flange mating faces F may be designed separately according to the matching requirements of the machines. TRUMY standard coupling series will also be your preferred selection in order to obtain optimum price and shorter lead time.
2. Based on the needs the connection between the driving and driven machines may be designed with taper bored hub (with or without key), expansion sleeve, flange, spline, etc. For straight bore connection to be applied the hub-shaft fit types list in the table are recommended.

Fit type	Bore tolerance for hub	Recommendation for shaft tolerance	Mounting method
Clearance fit, with single or double key connection	F7	h6	Cold mounting, with a setscrew on the keyway top
Transition fit, with single or double key connection	H7	k6 m6 n6	Hot mounting
Interference fit, with single or double key connection		r6 s6 t6 u6	Hot mounting
	P7	h6	Hot mounting

3. In the catalogue the total weight, centre of gravity, torsional stiffness and moment of inertia are calculated according to max. allowable bore Diameter, big hub, standard hub length and minimum distance between flange mating faces recommended. For other sizes of bore diameter, hub outside diameter, hub Length and distance between flange mating faces, above mentioned parameters should be calculated or corrected separately, where the torsional stiffness is taken in the fitting section of the shaft. For various distances between Flange mating faces the torsional stiffness K can be calculated using the formula as follows:

$$\frac{1}{K} = \frac{1}{K_T} + \frac{\Delta L}{\Delta K_T}$$

Where K- torsional stiffness for a given distance between flange mating faces, K_T- torsional stiffness shown in the catalogue, ΔK_T- torsional stiffness for spacer tube per meter as shown in the catalogue, ΔL- variation of size F relative to TRUMY recommended minimum distance between flange mating faces.

4. The "minimum" distance between flange mating faces F is referred to as the shortest distance between flange mating faces which meets the conditions of part machining technology and installing space for the structure. The "minimum" distance selection is not recommended due to its low performance-price ratio. If shorter distances are needed, please select DJ4, TDJ or L series from TRUMY couplings, or contact TRUMY sales engineer.
5. Double disc pack types of TRUMY couplings are recommended, for those couplings have big capacity to accommodate misalignments and high effectiveness in operation. If the space between the shaft ends limited, the single disc pack type may be applied. In this case, with the coupling type compensating ability lowered, a great attention should be paid to coupling centering in installation. When single disc pack structure be selected, the max. Axial displacement is only half of the data listed in the table.
6. Peak torque rating is the max. torque the coupling can tolerate for short period. momentary torque limit is the torque that corresponds to a factor of safety of 1.0 with respect to the most highly stressed component's material yield strength, allowing for a combination of speed, angular misalignment and axial displacement.
7. The max unbalanced speed is suitable for the application where DBFE does not exceed the value TRUMY recommended. In case of higher Speed or longer DBFE, dynamic balance is needed.
8. If you have any questions or any other particular requirements, please consult TRUMY sales engineer.

Technical Data

Type	Continuous Torque Rating (KNm)	Peak Torque Rating ⁽⁶⁾ (KNm)	Momentary Torque Limit ⁽⁶⁾ (KNm)	Max Speed (r/min)		Tightening Torque(Nm)	Weight of Total Coupling ⁽⁹⁾ (Kg)	Centre of Gravity x ⁽⁹⁾ (mm)	Torsional Stiffness K _T ⁽¹⁰⁾ (MNm/Rad)	Moment of Inertia ⁽¹¹⁾ (Kgm ²)	Spacer Tube Per m			Angular Misalignment		Axial Displacement	
				Unbalanced ⁽⁷⁾	Balanced						Weight (Kg)	Torsional Stiffness ΔK _T ⁽⁸⁾ (MNm/Rad)	Moment of Inertia (Kgm ²)	Max (deg)	Restoring Moment (Nm/deg)	Max ⁽⁸⁾ (±mm)	Axial Force (N)
D4-4	0.04	0.14	0.3	3600	9700	4	1.7	31.7	0.024	0.0012	4.32	0.014	0.001	1	15.4	2	185
D4-6	0.063	0.2	0.4	3600	8400	4	2.4	41.6	0.027	0.0022	4.93	0.020	0.002	1	19.4	2.5	215
D4-14	0.14	0.4	0.7	3600	7600	5	3.4	54.9	0.039	0.0038	6.17	0.040	0.004	1	22.9	2.8	315
D4-22	0.2	0.63	1.5	3600	6300	7	5.8	61.8	0.037	0.0098	9.47	0.099	0.0098	1	15	3.4	290
D4-44	0.4	1.0	1.75	3600	5800	10	6.9	60.8	0.059	0.014	10.95	0.154	0.015	1	20.5	3.9	515
D4-112	1.0	2.0	3.1	3600	5200	25	9.9	73.8	0.094	0.025	12.43	0.224	0.022	1	25.2	4.0	700
D4-142	1.4	3.55	5.3	3600	4300	45	15.5	78.0	0.23	0.056	14.80	0.378	0.037	1	37.9	5.9	1630
D4-220	2.0	6.3	10.0	3600	3800	80	20.0	79.5	0.29	0.091	21.70	0.673	0.066	1	44.8	6.4	2150

Main Dimintions(mm)

Type	Max.flange diameter,A	Disc pack thickness, G	Allowable bore diameter d/ Hub outside diameter C ⁽¹⁾			Hub Length, E ⁽¹⁾		Distance Between Flange Ends, F ⁽¹⁾⁽⁴⁾							
			Small hub		Big hub	Standard series	Big length series	TRUMY recommendation ("O"-recommended, "X"-no application)						Min.	
			80	100	140	180	200	250							
D4-4	78	7.2	d≤28/C=42			35	60	O	O	X	X	X	X	50	
D4-6	90	7.2	d≤38/C=54			50	80	O	O	O	X	X	X	50	
D4-14	100	8.4	d≤42/C=60			70	110	X	O	O	O	X	X	50	
D4-22	120	9.5	d≤55/C=77			80	110	X	O	O	O	X	X	60	
D4-44	130	10.7	d≤60/C=85			80	140	X	O	O	O	X	X	60	
D4-112	146	11.1	d≤55	80	55 < d ≤ 70	97	100	140	X	X	O	O	O	X	65
D4-142	176	13.6	d≤60	90	60 < d ≤ 75	108	100	140	X	X	X	O	O	O	80
D4-220	196	15.2	d≤70	105	70 < d ≤ 90	125	100	170	X	X	X	O	O	O	90

DJ4 series

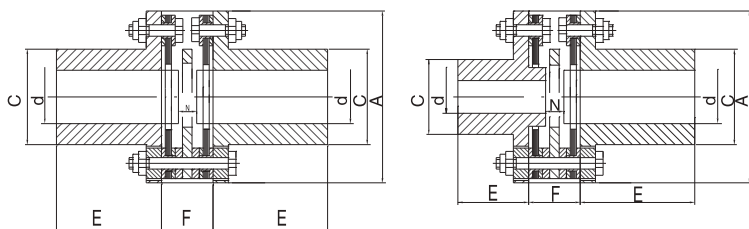

- ◆ Suitable for small power (continuous torque rating less than 2 KNm), low speed, close coupled shafts applications that need a compact coupling type.
- ◆ Having good capacity to accommodate misalignments, easy mounting/dismounting, in spite of small distance between the shaft ends.
- ◆ For higher torque and small distance between the shaft ends applications please select TDJ series.

Direction for use

1. Bore diameter d, hub outside diameter C, hub length E may be designed separately according to the matching requirements of the machines. TRUMY standard coupling series will also be your preferred selection in order to obtain optimum price and shorter lead time.
2. This series is designed for compact type application, The compact type couplings are usually designed specifically for sizes between the shaft ends. When necessary, the hub may be designed with the partial or full inversion form.

Fit type	Bore tolerance for hub	Recommendation for shaft tolerance	Mounting method
Clearance fit, with single or double key connection	F7	h6	Cold mounting, with a setscrew on the keyway top
Transition fit, with single or double key connection	H7	k6 m6 n6	Hot mounting
		r6 s6 t6 u6	Hot mounting
Interference fit, with single or double key connection	P7	h6	Hot mounting

3. Based on the needs the connection between the driving and driven machines may be designed with taper bored hub (with or without key), expansion sleeve, spline, etc. For straight bore connection to be applied the hub-shaft fit types list in the table are recommended.
4. In the catalogue the total weight, centre of gravity, torsional stiffness and moment of inertia are calculated according to max. allowable bore diameter, big hub and standard hub length. For other sizes of bore diameter, hub outside diameter and hub length above mentioned parameters should be calculated or corrected separately.
5. Peak torque rating is the max. torque the coupling can tolerate for short period. momentary torque limit is the torque that corresponds to a factor of safety of 1.0 with respect to the most highly stressed component's material yield strength, allowing for a combination of speed, angular misalignment and axial displacement.
6. If you have any questions or any other particular requirements, please consult TRUMY sales sales engineer.

Tecnical Data

Type	Continuous Torque Rating (KNm)	Peak Torque Rating ⁽⁵⁾ (KNm)	Momentary Torque Limit ⁽⁵⁾ (KNm)	Max Speed (r/min)	Tightening Torque (Nm)	Weight of Total Coupling ⁽⁶⁾ (Kg)	Centre of Gravity x ⁽⁴⁾ (mm)	Torsional Stiffness Kr ⁽⁴⁾ (MNm/Rad)	Moment of Inertia ⁽⁴⁾ (Kgm ²)	Angular Misalignment		Axial Displacement	
										Max (deg)	Restoring Moment (Nm/deg)	Max (±mm)	Axial Force (N)
DJ4-4	0.04	0.14	0.3	9700	4	1.2	28.1	0.024	0.00074	1	15.4	2	185
DJ4-6	0.063	0.2	0.4	8400	4	1.8	36.6	0.027	0.0015	1	19.4	2.5	215
DJ4-14	0.14	0.4	0.7	7600	5	2.6	51.0	0.039	0.0027	1	22.9	2.8	315
DJ4-22	0.2	0.63	1.5	6300	7	4.7	57.0	0.037	0.0073	1	15	3.4	290
DJ4-44	0.4	1.0	1.75	5800	10	5.7	55.8	0.059	0.010	1	20.5	3.9	515
DJ4-112	1.0	2.0	3.1	5200	25	8.4	68.7	0.094	0.019	1	25.2	4.0	700
DJ4-142	1.4	3.55	5.3	4300	45	13.2	72.6	0.23	0.041	1	37.9	5.9	1630
DJ4-220	2.0	6.3	10.0	3800	80	16.9	77.6	0.30	0.069	1	44.8	6.4	2150

Main Dimintions(mm)

Type	Max. flange diameter, A	Allowable bore diameter d/ Hub outside diameter C ⁽¹⁾			Std Hub Length ⁽¹⁾	Distance Between Flange Ends	Min. DBSE	
		Small hub	Big hub					
DJ4-4	78	d ≤ 28/C=42			35	27	5	
DJ4-6	90	d ≤ 38/C=54			50	27	5	
DJ4-14	100	d ≤ 42/C=60			70	36	5	
DJ4-22	120	d ≤ 55/C=77			80	42	5	
DJ4-44	130	d ≤ 60/C=85			80	44	5	
DJ4-112	146	d ≤ 55	100	55 < d ≤ 70	97	100	45	6
DJ4-142	176	d ≤ 60	100	60 < d ≤ 75	108	100	55	7
DJ4-220	196	d ≤ 70	100	70 < d ≤ 90	125	100	64	8

TD Series

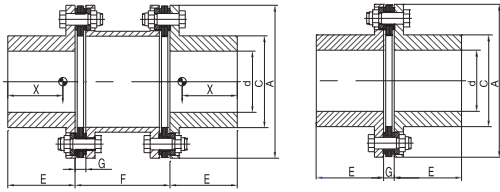

Single disc pack structure⁽⁵⁾



- ◆ First choice for middle/low speed applications
- ◆ Simple structure, easy to mount/dismount
- ◆ Widely applicable to pumps and fan sets
- ◆ For the machines with continuous torque rating less than 2KNm, if more compensating capacity is required, D4 series should be selected.

Direction for use

- Bore diameter d, hub outside diameter C, hub length E, distance between flange mating faces F may be designed separately according to the matching requirements of the machines. TRUMY standard coupling series will also be your preferred selection in order to obtain optimum price and shorter lead time.
- Based on the needs the connection between the driving and driven machines may be designed with taper bored hub (with or without key), expansion sleeve, flange, spline, etc. For straight bore connection to be applied the hub-shaft fit types list in the table are recommended.

Fit type	Bore tolerance for hub	Recommendation for shaft tolerance	Mounting method
Clearance fit, with single or double key connection	F7	h6	Cold mounting, with a setscrew on the keyway top
Transition fit, with single or double key connection	H7	k6 m6 n6	Hot mounting
		r6 s6 t6 u6	Hot mounting
Interference fit, with single or double key connection	P7	h6	Hot mounting

- In the catalogue the total weight, centre of gravity, torsional stiffness and moment of inertia are calculated according to max. allowable bore Diameter, big hub, standard hub length and minimum distance between flange mating faces recommended. For other sizes of bore diameter, hub outside diameter, hub length and distance between flange mating faces, above mentioned parameters should be calculated or corrected separately, where the torsional stiffness is taken in the fitting section of the shaft. For various distances between flange mating faces the torsional stiffness K can be calculated using the formula as follows:

$$\frac{1}{K} = \frac{1}{K_T} + \frac{\Delta L}{\Delta K_T}$$

Where K- torsional stiffness for a given distance between flange mating faces, K_T- torsional stiffness shown in the catalogue, ΔK_T- torsional stiffness for spacer tube per meter as shown in the catalogue, ΔL- variation of size F relative to TRUMY recommended minimum distance between flange mating faces.

- The "minimum" distance between flange mating faces F is referred to as the shortest distance between flange mating faces which meets the conditions of part machining technology and installing space for the structure. The "minimum" distance selection is not recommended due to its low performance-price ratio. If shorter distances are needed, please select DJ4, TDJ or L series from TRUMY couplings, or contact TRUMY sales engineer.
- Double disc pack types of TRUMY couplings are recommended, for those couplings have big capacity to accommodate misalignments and high effectiveness in operation. If the space between the shaft ends limited, the single disc pack type may be applied. In this case, with the coupling type compensating ability lowered, a great attention should be paid to coupling centering in installation.
- When single disc pack structure be selected, the max. Axial displacement is only half of the data listed in the table.
- Peak torque rating is the max. torque the coupling can tolerate for short period. Momentary torque limit is the torque that corresponds to a factor of safety of 1.0 with respect to the most highly stressed component's material yield strength, allowing for a combination of speed, angular misalignment and axial displacement.
- The max unbalanced speed is suitable for the application where DBFE does not exceed the value TRUMY recommended. In case of higher Speed or longer DBFE, dynamic balance is needed.
- If you have any questions or any other particular requirements, please consult TRUMY sales engineer.

Tecnical Data & Main Dimensions (mm)

Type	Continuous Torque Rating (KNm)	Peak Torque Rating ⁽⁴⁾ (KNm)	Momentary Torque Lmt ⁽⁵⁾ (KNm)	Max Speed (r/min)		Tightening Torque (Nm)	Weight of Total Coupling (Kg)	Centre of Gravity X _G (mm)	Torsional Stiffness K _T ⁽⁶⁾ (Mnm/Rad)	Moment of Inertia ⁽⁷⁾ (Kg·m ²)	Spacer Tube Per m			Angular Misalignment		Axial Displacement		Max. flange diameter, A	Thickness of a disc pack, G	Allowable bore diameter d / Hub outside diameter C ⁽¹⁾		Hub Length, E ⁽¹⁾		Distance Between Flange Ends, F ⁽¹⁾⁽⁶⁾										
				Unbalanced ⁽⁷⁾	Balanced						Weight (Kg)	Torsional Stiffness ΔK _T (Mnm/Rad)	Moment of Inertia (Kg·m ²)	Max (deg)	Restoring Moment (Nm/deg)	Max (mm)	Axial Force (N)			Small hub	Big hub	Standard series	Big length series	TRUMY recommendation (°=recommended, X=no application)										
				50	80						100	140	180	200	250	300	Min.																	
TD6-4	0.04	0.1	0.13	3600	29000	3	0.5	21.0	0.007	0.0002	3.5	0.007	0.0007	2/3	155	1	60	55	4.5	d≤22	34	--	--	25	35	O	X	X	X	X	X	X	X	35
TD6-11	0.1	0.2	0.3	3600	24600	8	0.9	28.4	0.011	0.0004	2.7	0.009	0.0008	2/3	160	1.2	140	65	6.2	d≤25	39	--	--	35	50	O	X	X	X	X	X	X	X	40
TD6-21	0.2	0.5	0.7	3600	20000	8	1.4	30.9	0.024	0.001	3.2	0.013	0.001	2/3	175	1.4	250	78	7.7	d≤30	44	--	--	35	60	X	O	X	X	X	X	X	X	50
TD6-42	0.4	1	1.3	3600	16800	8	2.7	40.1	0.044	0.003	3.8	0.026	0.003	2/3	180	1.6	340	95	7.2	d≤38	58	--	--	50	80	X	O	X	X	X	X	X	X	50
TD6-66	0.63	2	2.7	3600	14500	15	4.4	48.2	0.144	0.0066	5.3	0.051	0.005	2/3	200.8	2	510	114	10.7	d≤40	65	40<d≤50	74	60	110	X	O	O	O	X	X	X	X	55
TD6-150	1.4	2.5	3.3	3600	11800	15	7.0	59.1	0.147	0.015	8.82	0.143	0.014	2/3	114.5	2.3	830	136	10.7	d≤55	84	55<d≤65	92	80	110/140	X	X	O	O	O	O	X	X	55
TD6-210	2	5.4	7.2	3600	10300	25	10.3	65.7	0.213	0.029	9.93	0.203	0.020	2/3	157.9	2.6	1070	153	12	d≤65	94	65<d≤75	106	90	140	X	X	O	O	O	O	X	X	60
TD6-370	3.55	8.6	11.5	3600	8880	45	16.5	75.1	0.463	0.062	11.49	0.314	0.031	2/3	227	2.9	1630	174	13.3	d≤75	108	75<d≤85	121	100	140/170	X	X	O	O	O	O	X	X	75
TD6-470	4.5	9.8	13	3600	7800	45	23.0	86.0	0.466	0.12	15.04	0.571	0.056	2/3	203.3	3.5	1860	196	13.3	d≤85	127	85<d≤100	140	120	170/210	X	X	X	O	O	O	O	X	75
TD6-520	5	11.6	15.4	3600	6800	45	34.5	94.1	0.655	0.22	21.60	1.175	0.115	2/3	147.9	3.5	1430	226	13	d≤105	152	105<d≤120	168	140	170/210	X	X	X	O	O	O	X	75	
TD6-840	8	19.5	26	3600	6700	100	34.4	102.4	0.870	0.23	19.73	1.066	0.105	2/3	198.1	3.6	2510	230	15.2	d≤105	152	105<d≤120	161	140	170/210	X	X	X	O	O	O	O	85	
TD6-1300	12.5	27.1	36.1	3600	6200	150	48.0	113.5	1.476	0.37	23.38	1.489	0.146	2/3	526.4	3.6	3220	250	17.4	d≤110	164	110<d≤130	179	160	210/250	X	X	X	O	O	O	O	90	
TD6-2100	20	36.1	48.1	1800	5580	180	59.2	123.0	1.496	0.57	30.21	2.361	0.232	2/3	435.6	3.8	4550	276	20.4	d≤125	182	125<d≤145	195	170	210/250	X	X	X	X	O	O	O	100	
TD6-2700	25	38.8	51.6	1800	5180	180	76.2	137.8	1.523	0.82	32.97	3.069	0.301	2/3	382.9	3.8	4860	296	20.4	d≤135	198	135<d≤155	211	200	250	X	X	X	X	O	O	O	100	
TD6-3300	31.5	61.7	82	1800	4680	350	107.3	143.5	2.588	1.45	44.12	4.989	0.490	2/3	533.3	4.8	6150	326	22.8	d≤150	219	150<d≤170	235	200	250/300	X	X	X	X	X	O	O	125	
TD6-4200	40	85.7	114	1800	4180	500	147.2	167.3	4.114	2.48	57.21	7.860	0.771	2/3	707.6	6	8070	366	27.6	d≤165	242	165<d≤190	258	230	300	X	X	X	X	X	O	O	140	

TD8-840	8	14.7	19.5	3600	7800	45	26.1	97.7	1.077	0.14	19.09	0.811	0.080	1/2	651.3	2	2240	202	13.3	d≤90	135	90<d≤110	148	140	170/210									180	75
TD8-1700	16	35.9	47.8	3600	6600	150	39.5	104.4	2.484	0.27	25.03	1.344	0.132	1/2	1533	2.2	4030	235	17.5	d≤105	152	105<d≤120	165	140	170/210									180	90
TD8-2700	25	47.4	63	1800	6100	180	50.0	119.3	2.868	0.40	28.95	1.810	0.178	1/2	1495	2.4	5930	252	20.4	d≤110	165	110<d≤130	177	160	210/250									200	100
TD8-3300	31.5	55.4	73.7	1800	5250	180	75.8	124.7	3.746	0.80	32.97	3.069	0.301	1/2	1130	3	6380	292	20.4	d≤135	198	135<d≤150	212	180	250									200	100
TD8-4200	40	92.5	123	1800	4500	350	116.9	141.7	5.192	1.76	42.27	6.133	0.602	1/2	1999	3.8	7240	340	22.8	d≤160	234	160<d≤180	249	200	250/300									250	125
TD8-6600	63	124	165	1800	4250	500	146.8	152.7	8.73	2.52	58.69	8.485	0.833	1/2	3338	4.2	11350	364	27.6	d≤170	248	170<d≤190	264	210	250/300									250	140
TD8-8400	80	171	228	1800	3880	700	194.2	184.0	13.65	3.81	75.37	11.509	1.129	1/2	8431	4.8	15380	395	33	d≤175	257	175<d≤200	277	250	300/350									300	155
TD8-9011	100	191	254	1800	3580	700	228.3	179.6	15.18	5.42	79.83	16.14	1.584	1/2	6401	5.2	16090	428	33	d≤200	293	200<d≤230	313	250	300/350									300	155
TD8-9015	140	300	400	1200	3200	1200	316.2	185.9	19.84	9.54	104.37	26.183	2.57	1/2	6357	5.5	19330	478	34	d≤220	327	220<d≤250	346	250	350/410									350	180
TD8-9021	200	337	448	--	3000	1200	423.6	212.8	23.12	15.85	132.80	43.682	4.29	1/2	7386	6	23110	532	34	d≤255	374	255<d≤290	393	300	350/410									400	180
TD8-9026	250	503	669	--	3000	1900	636.0	248.5	32.57	29.54	168.95	70.033	6.87	1/2	8478	7	27310	592	38.6	d≤290	420	290<d≤320	439	350	410/470									450	205

TD10-5300	50	119	159	1800	4500	350	119.6	143.6	9.68	1.80	47.27	6.13	0.60	1/4	9547	2.8	8750	340	24.4	d≤160	234	160<d≤180	249	200	250/300									250	125
TD10-8400	80	159	212	1800	4250	500	149.4	154.3	13.56	2.58	58.69	8.485	0.83	1/4	13740	3	13630	364	28.8	d≤170	248	170<d≤190	264	210	250/300									250	140
TD10-9011	100	220	293	1200	3880	700	201.4	186.3	18.15	3.88	75.37	11.509	1.13	1/4	30120	3	17810	395	33	d≤175	257	175<d≤200	277	250	300/350									300	155
TD10-9013	125	246	327	1200	3580	700	233.0	181.5	23.97	5.56	79.83	16.144	1.58	1/4	26750	3.7	18970	428	33	d≤200	293	200<d≤230	313	250	300/350									300	155
TD10-9019	180	387	515	1200	3200	1200	324.9	188.9	34.12	9.85	104.37	26.18	2.57	1/4	29000	4.2	25290	478	37	d≤220	327	220<d≤250	346	250	350/410									350	180
TD10-9023	224	433	576	--	3000	1200	434.0	216.0	43.31	16.31	132.80	43.68	4.29	1/4	33400	5	28300	532	37	d≤255	374	255<d≤290	393	300	350/410									400	180
TD10-9033	315	647	861	--	3000	1900	654.0	252.5	59.63	30.58	168.9	70.03	6.87	1/4	37650	5.8	37500	592	41.6	d≤290	420	290<d≤320	439	350	410/470									450	205

TDJ Series

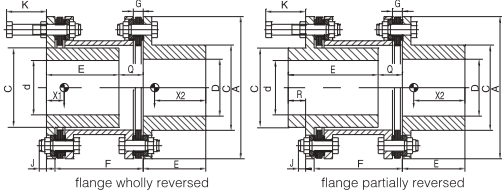

- ◆ Derivative from TD series, suitable for short distance between shaft ends (compact type) and low speed applications.
- ◆ Compact structure, but replacement of disc packs may be time consuming.
- ◆ For continuous torque rating less than 2KNm, DJ4 series may be also Selected.
- ◆ For shorter distance between shaft ends and some low speed applications L series should be selected, for it is easy for the coupling parts to be replaced with spare ones.

Direction for use

- Bore diameter d & D, hub outside diameter C, hub length E, distance between flange mating faces F may be designed separately according to the matching requirements of the machines. TRUMY standard coupling parameter values and recommendations will also be your preferred selection in order to obtain optimum price and shorter lead time. (Hub outside diameter of the reversed hub has a standard value C_{rev})
- Based on the needs the connection between the driving and driven machines may be designed with taper bored hub (with or without key), expansion sleeve, flange, spline, etc. For straight bore connection to be applied the hub-shaft fit types list in the table are recommended.

Fit type	Bore tolerance for hub	Recommendation for shaft tolerance	Mounting method
Clearance fit, with single or double key connection	F7	h6	Cold mounting, with a setscrew on the keyway top
Transition fit, with single or double key connection	H7	k6 m6 n6	Hot mounting
Interference fit, with single or double key connection	P7	r6 s6 t6 u6	Hot mounting
		h6	Hot mounting

- In the catalogue the total weight, centre of gravity, moment of inertia are calculated according to max. Allowable bore diameter (for both d and D), big hub outside diameter (if in inversion form, according to standard hub outside diameter), standard hub length and standard distance between flange mating faces (where the center of gravity X1 is calculated according to the hub in full inversion form). For other sizes of bore diameter, hub outside diameter, hub length and distance between flange mating faces, above mentioned parameters should be calculated or corrected separately, where the torsional stiffness is taken in the fitting section of the shaft. For various distances between flange mating faces the torsional stiffness K can be calculated using the formula as follows:

$$\frac{1}{K} = \frac{1}{K_T} + \frac{\Delta L}{\Delta K_T}$$

Where K – torsional stiffness for a given distance between flange mating faces, K_T – torsional stiffness shown in the catalogue, ΔK_T – torsional stiffness for spacer tube per meter as shown in the catalogue, ΔL – variation of size F relative to TRUMY recommended minimum distance between flange mating faces.

- The "minimum" distance between flange mating faces F is referred to as the shortest distance between flange mating faces which meets the conditions of part machining technology and installing space for the structure. The "minimum" distance selection is not recommended due to its low performance-price ratio.
- In case of limited space between the shaft ends. The TRUMY standard DBSE is recommended, and the hub in a partial inversion form may be used as shown in the fig., where the size R shall be defined on the basis of the concrete structure.
- Peak torque rating is the max. torque the coupling can tolerate for short period. Momentary torque limit is the torque that corresponds to a factor of safety of 1.0 with respect to the most highly stressed component's material yield strength, allowing for a combination of speed, angular misalignment and axial displacement.
- The max unbalanced speed is suitable for the application where DBFE does not exceed the value TRUMY recommended. In case of higher speed or longer DBFE, dynamic balance is needed.
- If you have any questions or any other particular requirements, please consult TRUMY sales engineer.

Tecnical Data & Main Dimensions (mm)

Type	Continuous Torque Rating (KNm)	Peak Torque Rating (KNm)	Momentary Torque Limit (KNm)	Max. Speed (r/min)		Tightening Torque (Nm)	Weight of Total Coupling (Kg)	Centre of Gravity x^{cm} (mm)	Torsional Stiffness K_T^{cm} (MNm/Rad)	Moment of Inertia I^{cm} (Kg m^2)	Spacer Tube Per m			Angular Misalignment (Max. deg)	Axial Displacement		Max. flange diameter, A	Thickness of a disc pack, G	Allowable bore diameter, d/ Standard hub outside diameter, C ^d		Hub diameter C at permissible shaft diameter D ^h		Hub Length E ^h		Distance Between Flange Mating Faces, F ^{min}		Height of bolt projecting J	Bolt installation space, K	Min. flange recess, Q				
				Unbalanced	Balanced						Weight (Kg)	Torsional Stiffness ΔK_T (MNm/Rad)	Moment of Inertia (Kg m^2)		Max. (mm)	Max. Force (N)			d	std	Small hub	Big hub	Stand-ard series	Big length series	TRUMY standard	Min.							
TDJ6-66	0.63	2	2.7	3600	14500	15	4.0	15.9	48.2	0.13	0.0060	5.3	0.051	0.005	2/3	200.8	2	510	114	10.7	40	55	D \leq 40	65	40 < D \leq 74	74	60	110	80	55	9.3	41	12
TDJ6-150	1.4	2.5	3.3	3600	11800	15	6.3	22.8	59.1	0.14	0.013	8.82	0.143	0.014	2/3	114.5	2.3	830	136	10.7	50	71	D \leq 55	84	55 < D \leq 65	92	80	110/140	100	55	9.3	41	12
TDJ6-210	2	5.4	7.2	3600	10300	25	9.1	24.8	65.7	0.20	0.025	9.93	0.203	0.020	2/3	157.9	2.6	1070	153	12	60	81	D \leq 65	94	65 < D \leq 75	106	90	140	100	60	10	48	15
TDJ6-370	3.55	8.6	11.5	3600	8880	45	14.9	27.9	75.1	0.44	0.055	11.49	0.314	0.031	2/3	227	2.9	1630	174	13.3	70	95	D \leq 75	108	75 < D \leq 85	121	100	140/170	140	75	17.2	61.5	15
TDJ6-470	4.5	9.8	13	3600	7800	45	21.2	36.0	86.0	0.45	0.10	15.04	0.571	0.056	2/3	203.3	3.5	1860	196	13.3	80	113	D \leq 85	127	85 < D \leq 100	140	120	170/210	140	75	17.2	61.5	15
TDJ6-523	5	11.6	15.4	3600	6800	45	31.3	45.2	94.1	0.63	0.19	21.60	1.175	0.115	2/3	147.9	3.5	1430	226	13	95	135	D \leq 105	152	105 < D \leq 120	168	140	170/210/210	140	75	17.5	61.5	15
TDJ6-840	8	19.5	26	3600	6700	100	33.5	43.2	102.4	0.84	0.21	19.73	1.066	0.105	2/3	198.1	3.6	2510	230	15.2	95	135	D \leq 105	152	105 < D \leq 120	161	140	170/210	140	85	16.8	71	20
TDJ6-1300	12.5	27.1	36.1	3600	6200	150	44.4	48.5	113.5	1.40	0.33	23.38	1.489	0.146	2/3	526.4	3.6	3220	250	17.4	105	146	D \leq 110	164	110 < D \leq 130	179	160	210/250	180	90	20.6	78	20
TDJ6-2100	20	36.1	48.1	1800	5580	180	56.2	52.8	123.0	1.44	0.51	30.21	2.361	0.232	2/3	435.6	3.8	4550	276	20.4	115	162	D \leq 125	182	125 < D \leq 145	195	170	210/250	200	100	21.6	85	25
TDJ6-2700	25	38.8	51.6	1800	5180	180	72.0	65.8	137.8	1.38	0.73	32.97	3.069	0.301	2/3	382.9	3.8	4860	296	20.4	125	178	D \leq 135	198	135 < D \leq 155	211	200	250	200	100	21.6	85	25
TDJ6-3300	31.5	61.7	82	1800	4680	350	100.3	62.2	143.5	2.51	1.30	44.12	4.989	0.490	2/3	533.3	4.8	6150	326	22.8	140	196	D \leq 150	219	150 < D \leq 170	235	200	250/300	250	125	21.2	101	25
TDJ6-4200	40	85.7	114	1800	4180	500	139.3	70.2	167.3	3.96	2.24	57.21	7.860	0.771	2/3	707.6	6	8070	366	27.6	155	216	D \leq 165	242	165 < D \leq 190	258	230	300	250	140	25.4	116	30
TDJ8-840	8	14.7	19.5	3600	7800	45	24.4	44.3	97.7	0.99	0.12	19.09	0.811	0.080	1/2	651.3	2	2240	202	13.3	85	120	D \leq 90	135	90 < D \leq 110	148	140	170/210	140	75	17.2	61.5	15
TDJ8-1700	16	35.9	47.8	3600	6600	150	37.2	41.9	104.4	2.23	0.25	25.03	1.344	0.132	1/2	1533	2.2	4030	235	17.5	95	135	D \leq 105	152	105 < D \leq 120	165	140	170/210	180	90	20.5	78	20
TDJ8-2700	25	47.4	63	1800	6100	180	46.9	47.1	119.3	2.63	0.36	28.95	1.810	0.178	1/2	1495	2.4	5930	252	20.4	105	145	D \leq 110	165	110 < D \leq 130	177	160	210/250	200	100	21.6	85	25
TDJ8-3300	31.5	55.4	73.7	1800	5250	180	71.0	59.0	124.7	3.45	0.71	32.97	3.069	0.301	1/2	1130	3	6380	292	20.4	125	180	D \leq 135	198	135 < D \leq 150	212	180	250	200	100	21.6	85	25
TDJ8-4200	40	92.5	123	1800	4500	350	110.9	65.3	141.7	4.98	1.60	42.27	6.133	0.602	1/2	1999	3.8	7240	340	22.8	150	213	D \leq 160	234	160 < D \leq 180	249	200	250/300	250	125	21.2	101	25
TDJ8-6600	63	124	165	1800	4250	500	138.0	66.5	152.7	8.26	2.29	58.69	8.485	0.833	1/2	3338	4.2	11350	364	27.6	160	224	D \leq 170	248	170 < D \leq 190	264	210	250/300	250	140	25.4	116	30
TDJ8-8400	80	171	228	1800	3880	700	178.9	74.5	184.0	12.24	3.42	75.37	11.509	1.129	1/2	8431	4.8	15380	395	33	165	227	D \leq 175	257	175 < D \leq 200	277	250	300/350	300	155	27	127	35
TDJ8-9010	100	191	254	1800	3580	700	215.7	80.1	179.6	14.23	4.90	79.83	16.14	1.584	1/2	6401	5.2	16090	428	33	190	265	D \leq 200	293	200 < D \leq 230	313	250	300/350	300	155	27	127	35
TDJ8-9015	140	300	400	1200	3200	1200	300.9	78.9	185.9	18.89	8.78	104.37	26.183	2.57	1/2	6357	5.5	19330	478	34	210	295	D \leq 220	327	220 < D \leq 250	346	250	350/410	350	180	31	151	35
TDJ8-9021	200	337	448	--	3000	1200	407.6	96.7	212.8	22.17	14.53	132.80	43.682	4.29	1/2	7386	6	23110	532	34	240	339	D \leq 255	374	255 < D \leq 290	393	300	350/410	400	180	31	151	35
TDJ8-9026	250	503	669	--	3000	1900	606.7	114.2	248.5	31.32	27.02	168.95	70.033	6.87	1/2	8478	7	27310	592	38.6	270	380	D \leq 290	420	290 < D \leq 330	439	350	410/470	450	205	37.4	175	40
TDJ10-5300	50	119	159	1800	4500	350	113.3	64.8	143.6	8.94	1.64	47.27	6.13	0.60	1/4	9547	2.8	8750	340	24.4	150	213	D \leq 160	234	160 < D \leq 180	249	200	250/300	250	125	23.6	101	30
TDJ10-8400	80	159	212	1800	4250	500	140.5	66.2	154.3	12.43	2.34	58.69	8.485	0.83	1/4	13740	3	13630	364	28.8	160	224	D \leq 170	248	170 < D \leq 190	264	210	250/300	250	140	26.2	116	30
TDJ10-9011	100	220	293	1200	3880	700	185.2	73.5	186.3	15.74	3.48	75.37	11.509	1.13	1/4	30120	3.3	17810	395	33	165	227	D \leq 175	257	175 < D \leq 200	277	250	300/350	300	155	27	127	35
TDJ10-9013	125	246	327	1200	3580	700	220.4	79.5	181.5	37.32	5.04	79.83	16.144	1.58	1/4	26750	3.7	18970	428	33	190	265	D \leq 200	293	200 < D \leq 230	313	250	300/350	300	155	27	127	35
TDJ10-9018	180	387	515	1200	3200	1200	308.9	78.4	188.9	31.28	9.08	104.3	26.18	2.57	1/4	29000	4.2	25290	478	37	210	295	D \leq 220	327	220 < D \leq 250	346	250	350/410	350	180	34	151	40
TDJ10-9023	224	433	576	--	3000	1200	417.2	98.0	216.0	39.97	14.96	132.80	43.68	4.29	1/4	33400	5	28300	532	37	240	339	D \leq 255	374	255 < D \leq 290	393	300	350/410	400	180	34	151	40
TDJ10-9033	315	647	861	--	3000	1900	623.8	112.9	252.5	55.42	28.02	168.9	70.03	6.87	1/4	37650	5.8	37500	592	41.6	270	380	D \leq 290	420	290 < D \leq 330	439	350	410/470	450	205	40.4	175	45

L Series (compact structure with link form disc)

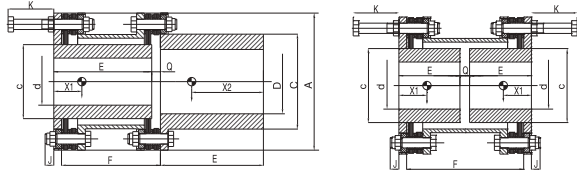

- ◆ The coupling series of compact type, suitable for short distance between the shaft ends and low speed applications.
- ◆ Coupling compact structure enabling disc packs and fasteners to be replaced without removing of the machines.

Direction for use

1. The compact type couplings are usually designed specifically for sizes between the shaft ends. When necessary, the hub may be designed with the partial inversion form as shown in the left fig., where the size R will be defined by the concrete structure.

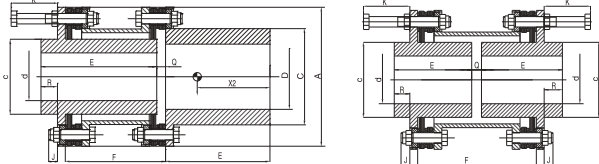

2. Based on the needs the connection between the driving and driven machines may be designed with taper bored hub (with or without key), expansion sleeve, flange, spline, etc. For straight bore connection to be applied the hub-shaft fit types list in the table are recommended.

Fit type	Bore tolerance for hub	Recommendation for shaft tolerance	Mounting method
Clearance fit, with single or double key connection	F7	h6	Cold mounting, with a setscrew on the keyway top
Transition fit, with single or double key connection	H7	k6 m6 n6	Hot mounting
Interference fit, with single or double key connection		r6 s6 t6 u6	Hot mounting
	P7	h6	Hot mounting

3. In the catalogue the total weight, centre of gravity, torsional stiffness and moment of inertia are calculated according to max. allowable bore diameter (for both d and D), big hub outside diameter (if in inversion form, according to standard hub outside diameter), standard hub length and standard distance between flange mating faces (where the center of mass X1 will be calculated according to the hubs in full inversion form). For other sizes of bore diameter, hub outside diameter, hub length and distance between flange mating faces, above mentioned parameters should be calculated or corrected separately, where the torsional stiffness is taken in the fitting section of the shaft, for various distances between flange mating faces the torsional stiffness K can be calculated using the formula as follows:

$$\frac{1}{K} = \frac{1}{K_T} + \frac{\Delta L}{\Delta K_T}$$

Where K- torsional stiffness for a given distance between flange mating faces, K_T - torsional stiffness shown in the catalogue, ΔK_T - torsional stiffness for spacer tube per meter as shown in the catalogue, ΔL - variation of size F relative to TRUMY recommended minimum distance between flange mating faces.

4. Shaft diameter d&D, hub outside diameter C, hub length E, distance between flange mating faces F may be designed separately according to the matching requirements of the machines. TRUMY standard coupling parameter values and TRUMY recommendations will also be your preferred selection in order to obtain optimum price and shorter lead time.

5. The minimum distance between flange mating faces F is referred to as the shortest distance between flange mating faces which meets the conditions of part machining technology and installing space for the structure. The minimum distance selection is not recommended due to its low performance-price ratio.

6. Peak torque rating is the max. torque the coupling can tolerate for short period. Momentary torque limit is the torque that corresponds to a factor of safety of 1.0 with respect to the most highly stressed component's material yield strength, allowing for a combination of speed, angular misalignment and axial displacement.

7. If you have any questions or any other particular requirements, please consult TRUMY sales engineer.

Tecnical Data & Main Dimensions (mm)

Type	Continuous Torque Rating (KNm)	Peak Torque Rating ⁽¹⁾ (KNm)	Momentary Torque Limit ⁽²⁾ (KNm)	Max Speed (r/min)	Tightening Torque(Nm)	Weight of Total Coupling ⁽³⁾ (Kg)	Centre of Gravity X ⁽⁴⁾ (mm)		Torsional Stiffness K _T ⁽⁵⁾ (MNm/Rad)	Moment of Inertia ⁽³⁾ (Kg·m ²)	Spacer Tube Per m			Angular Misalignment		Axial Displacement	
							Weight (Kg)	Torsional Stiffness ΔK_T (MNm/Rad)			Moment of Inertia (Kg·m ²)	Max (deg)	Restoring Moment (Nm/deg)	Max (±mm)	Axial Force (N)		
L6-580	5.6	8.1	9.3	3600	150	14.9	27.3	68.6	1.430	0.055	10.4	0.291	0.028	1/2	4805	1.1	1600
L6-740	7.1	9.9	11.5	3600	180	20.5	33.3	76.4	2.093	0.095	12.0	0.457	0.044	1/2	3924	1.2	1700
L6-840	8	11.7	13.5	3600	180	31.2	43.0	85.3	3.141	0.19	14.6	0.815	0.080	1/2	2962	2	2130
L6-1700	16	23.6	27.2	3600	350	42.4	45.7	100.3	5.152	0.32	23.7	1.546	0.152	1/2	6197	2.3	4030
L6-2100	20	29	33.3	1800	500	54.8	50.8	112.3	5.871	0.49	25.9	2.023	0.198	1/2	6282	2.3	4230
L6-2900	28	41.7	47.9	1800	500	66.2	55.8	116.2	6.939	0.69	28.3	2.629	0.258	1/2	6894	2.8	5970
L6-3700	35.5	52.7	60.5	1800	300	99.3	57.5	131.6	10.399	1.32	46.8	5.322	0.522	1/2	7400	2.9	6510
L6-4200	40	58.9	67.6	1800	300	131.9	64.7	147.1	15.101	2.16	51.9	7.256	0.712	1/2	6529	4.3	8410
L8-1200	11.2	15.1	17.3	3600	150	34.7	38.9	93.4	4.874	0.23	25.0	1.344	0.132	1/3	12088	1.1	2040
L8-1500	14	18.6	21.3	1800	180	44.2	45.0	104.5	5.600	0.34	19.5	1.240	0.122	1/3	9839	1.2	2180
L8-1700	16	21.8	25.1	1800	180	66.6	53.9	111.6	9.782	0.68	33.0	3.069	0.301	1/3	7369	2	2780
L8-3300	31.5	44	50.5	1800	350	113.7	63.5	135.6	15.06	1.66	44.8	5.887	0.578	1/3	15495	2.3	5170
L8-4200	40	53.9	62	1800	500	135.8	67.2	143.8	19.87	2.24	47.5	7.044	0.691	1/3	15733	2.3	5510
L8-5800	56	77.6	89.1	1800	500	170.5	67.2	157.8	24.58	3.21	55.3	8.742	0.858	1/3	17200	2.8	7660
L8-7400	71	98	112	1800	700	212.8	81.0	170.5	35.30	4.82	70.0	14.410	1.414	1/3	18494	2.9	8480
L8-8400	80	109.4	125	1200	700	297.2	85.7	186.3	46.14	8.41	92.9	23.377	2.294	1/3	16237	4.3	11000

Type	Max. flange diameter, A	Allowable bore diameter, d/ Standard hub outside diameter, c ⁽⁴⁾		Allowable shaft diameter, D/ Hub outside diameter, C ⁽⁴⁾		Hub Length E ⁽⁴⁾		Distance Between Flange Ends F ⁽⁴⁾⁽⁵⁾		Height of bolt projecting, J	Bolt installation space, K	Min. DBSE Recommended, Q		
		d	C _{std}	Small hub	Big hub	Standard series	Big length series	TRUMY standard	Min.					
L6-580	174	70	95	D ≤ 75	108	75 < D ≤ 85	121	100	140/170	140	75	17.2	61.5	15
L6-740	196	80	113	D ≤ 85	127	85 < D ≤ 100	140	120	170/210	140	75	17.2	61.5	15
L6-840	226	95	135	D ≤ 105	152	105 < D ≤ 120	168	140	170/210/210	140	75	17.5	61.5	15
L6-1700	250	105	146	D ≤ 110	164	110 < D ≤ 130	179	160	210/250	180	90	20.6	78	20
L6-2100	276	115	162	D ≤ 125	182	125 < D ≤ 145	195	170	210/250	200	100	21.6	85	25
L6-2900	296	125	178	D ≤ 135	198	135 < D ≤ 155	211	200	250	200	100	21.6	85	25
L6-3700	326	140	196	D ≤ 150	219	150 < D ≤ 170	235	200	250/300	250	125	21.2	101	25
L6-4200	366	155	216	D ≤ 165	242	165 < D ≤ 190	258	230	300	250	140	25.4	116	30
L8-1200	235	95	135	D ≤ 105	152	105 < D ≤ 120	165	140	170/210	180	90	20.5	78	20
L8-1500	252	105	145	D ≤ 110	165	110 < D ≤ 130	177	160	210/250	200	100	21.6	85	25
L8-1700	292	125	180	D ≤ 135	198	135 < D ≤ 150	212	180	250	200	100	21.6	85	25
L8-3300	340	150	213	D ≤ 160	234	160 < D ≤ 180	249	200	250/300	250	125	21.2	101	25
L8-4200	364	160	224	D ≤ 170	248	170 < D ≤ 190	264	210	250/300	250	140	25.4	116	30
L8-5800	395	165	227	D ≤ 175	257	175 < D ≤ 200	277	250	300/350	300	155	27	127	35
L8-7400	428	190	265	D ≤ 200	293	200 < D ≤ 230	313	250	300/350	300	155	27	127	35
L8-8400	478	210	295	D ≤ 220	327	220 < D ≤ 250	346	250	350/410	350	180	31	151	35

TDP Series

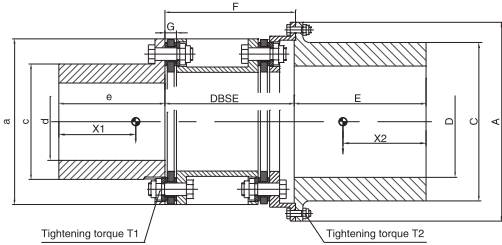

- ◆ Derivative from TD series, suitable for the shafts wide differing from each other in diameter and middle/low speed applications.
- ◆ Especially suitable for the equipment such as electric generators and electromotors with big diameter shafts.
- ◆ Beneficial to protection for small shaft equipment.

Direction for use

1. Shaft diameter d&D, hub outside diameter C, hub length e & E, distance between flange mating faces F may be designed separately According to the matching requirements of the machines. TRUMY standard coupling parameter values and recommendations should also be your preferred selection in order to obtain optimum price and shorter lead time.
2. Based on the needs the connection between the driving and driven machines may be designed with taper bonded hub (with or without key), expansion sleeve, flange, spline, etc. For straight bore connection to be applied the hub-shaft fit types list in the table are recommended.

Fit type	Bore tolerance for hub	Recommendation for shaft tolerance	Mounting method
Clearance fit, with single or double key connection	F7	h6	Cold mounting, with a setscrew on the keyway top
Transition fit, with single or double key connection	H7	k6 m6 n6	Hot mounting
		r6 s6 t6 u6	Hot mounting
Interference fit, with single or double key connection	P7	h6	Hot mounting

3. In the catalogue the total weight, centre of gravity, torsional stiffness and moment of inertia are calculated according to max. allowable bore diameter (for both d and D), standard hub length and minimum distance between flange mating faces recommended. For other sizes of bore diameter, hub outside diameter, hub length and distance between flange mating faces, above mentioned parameters should be calculated or corrected separately, where the torsional stiffness is taken in the fitting section of the shaft. For various distances between flange mating faces the torsional stiffness K can be calculated using the formula as follows:

$$\frac{1}{K} = \frac{1}{K_T} + \frac{\Delta L}{\Delta K_T}$$

Where K- torsional stiffness for a given distance between flange mating faces, K_T- torsional stiffness shown in the catalogue, ΔK_T- torsional stiffness for spacer tube per meter as shown in the catalogue, ΔL- variation of size F relative to TRUMY recommended minimum distance between flange mating faces.

4. The "minimum" distance between flange mating faces F is referred to as the shortest distance between flange mating faces which meets the conditions of part machining technology and installing space for the structure. The "minimum" distance selection is not recommended due to its low performance-price ratio.
5. Peak torque rating is the max. torque the coupling can tolerate for short period. Momentary torque limit is the torque that corresponds to a factor of safety of 1.0 with respect to the most highly stressed component's material yield strength, allowing for a combination of speed, angular misalignment and axial displacement.
6. The max unbalanced speed is suitable for the application where DBFE does not exceed the value TRUMY recommended. In case of higher speed or longer DBFE, dynamic balance is needed.
7. If you have any questions or any other particular requirements, please consult TRUMY sales engineer.

Tecnical Data & Main Dimensions (mm)

Type	Continuous Torque Rating (K Nm)	Peak Torque Rating (K Nm)	Momentary Torque Limit (K Nm)	Max. Speed (r/min)		Tightening Torque (Nm)		Weight of Total Coupling (Kg)	Moment of Inertia (Kgm ²)		Torsional Stiffness K _T (MNm/Rad)	Moment of Inertia ΔK _T (Kgm ²)		Spacer Tube Per m			Angular Misalignment (Deg)	Axial Displacement		Max. flange diameter	Allowable bore diameter d / standard hub outside diameter c	Allowable bore diameter, D/ hub outside diameter, C	Small hub length e ⁽¹⁾		Big hub length E ⁽¹⁾		Distance Between Flange Ends F ⁽¹⁾⁽⁴⁾							
				Unbalanced ⁽³⁾	Balanced	T1	T2		X1	X2		Weight (Kg)	Torsional Stiffness ΔK _T (MNm/Rad)	Moment of Inertia (Kgm ²)	Max (deg)	Restoring Moment (Nm/deg)		Max (mm)	Axial Force (N)				a	A	d	e	D	C	Standard series	Big length series	Standard series	Big length series	TRUMY recommended	Min.
TDP6-66	0.63	2	2.7	3600	14500	15	8	8.0	48.2	64.9	0.15	0.017	5.3	0.051	0.005	2/3	200.8	2	510	114	146	50	74	70	105	60	110	80	110/140	---	104	124	164	79
TDP6-150	1.4	2.5	3.3	3600	11800	15	8	8.5	59.1	72.5	0.15	0.021	8.82	0.143	0.014	2/3	114.5	2.3	830	136	168	65	92	85	127	80	110/140	100	140/170	124	164	204	224	79
TDP6-210	2	5.4	7.2	3600	10300	25	8	18.6	65.7	84.9	0.22	0.072	9.93	0.203	0.020	2/3	157.9	2.6	1070	153	188	75	106	100	150	90	140	120	170/210	130	170	210	230	90
TDP6-370	3.55	8.6	11.5	3600	8880	45	8	29.8	75.1	99.6	0.48	0.15	11.49	0.314	0.031	2/3	227	2.9	1630	174	212	85	121	115	175	100	140/170	140	170/210	175	215	235	285	110
TDP6-470	4.5	9.8	13	3600	7800	45	8	40.5	86.0	110.4	0.48	0.26	15.04	0.571	0.056	2/3	203.3	3.5	1860	196	236	100	140	130	195	120	170/210	160	210/250	176	216	236	286	111
TDP6-523	5	11.6	15.4	3600	6800	45	15	63.5	94.1	129.4	0.66	0.56	21.60	1.175	0.115	2/3	147.9	3.5	1430	226	272	120	168	155	230	140	170/210	200	250	176	216	236	286	111
TDP6-840	8	19.5	26	3600	6700	100	15	64.9	102.4	133.8	0.89	0.58	19.73	1.066	0.105	2/3	198.1	3.6	2510	230	272	120	161	155	230	140	170/210	200	250	218	238	288	338	123
TDP6-1300	12.5	27.1	36.1	3600	6200	150	15	81.6	113.5	137.6	1.52	0.86	23.38	1.489	0.146	2/3	526.4	3.6	3220	250	300	130	179	170	250	160	210/250	200	250/300	223	243	293	343	133
TDP6-2100	20	36.1	48.1	1800	5580	180	15	98.5	123.0	137.5	1.53	1.23	30.21	2.361	0.232	2/3	435.6	3.8	4550	276	316	145	195	185	274	170	210/250	200	250/300	---	246	296	346	146
TDP6-2700	25	38.8	51.6	1800	5180	180	45	134.2	137.8	165.5	1.56	1.94	32.97	3.069	0.301	2/3	382.9	3.8	4860	296	348	155	211	195	290	200	250	250	300/350	---	246	296	346	151
TDP6-3300	31.5	61.7	82	1800	4680	350	45	179.4	143.5	170.4	2.65	3.23	44.12	4.989	0.490	2/3	533.3	4.8	6150	326	385	170	235	220	328	200	250/300	250	300/350	---	---	300	350	175
TDP6-4200	40	85.7	114	1800	4180	500	45	232.2	167.3	175.3	4.25	5.19	57.21	7.860	0.771	2/3	707.6	6	8070	366	425	190	258	250	369	230	300	250	350/410	---	---	310	360	200
TDP8-840	8	14.7	19.5	3600	7800	45	8	42.1	97.7	110.6	1.11	0.28	19.09	0.811	0.080	1/2	651.3	2	2240	202	236	110	148	130	195	140	170/210	160	210/250	---	216	---	111	
TDP8-1700	16	35.9	47.8	3600	6600	150	15	76.9	104.4	141.0	2.63	0.72	25.03	1.344	0.132	1/2	1533	2.2	4030	235	282	120	165	155	235	140	170/210	200	250	---	222	---	132	
TDP8-2700	25	47.4	63	1800	6100	180	15	88.2	119.3	138.8	3.08	0.98	28.95	1.810	0.178	1/2	1495	2.4	5930	252	305	130	177	175	260	160	210/250	200	250/300	---	246	---	146	
TDP8-3300	31.5	55.4	73.7	1800	5250	180	45	134.2	124.7	165.9	3.92	1.94	32.97	3.069	0.301	1/2	1130	3	6380	292	348	150	212	195	290	180	250	250	300/350	---	246	---	146	
TDP8-4200	40	92.5	123	1800	4500	350	45	196.7	141.7	168.2	5.37	3.91	42.27	6.133	0.602	1/2	1999	3.8	7240	340	404	180	249	230	345	200	250/300	250	300/350	---	300	---	175	
TDP8-6600	63	124	165	1800	4250	500	45	232.3	152.7	175.4	9.17	5.18	58.69	8.485	0.833	1/2	3338	4.2	11350	364	425	190	264	245	365	210	250/300	250	350/410	---	307	---	197	
TDP8-8400	80	171	228	1800	3880	700	45	311.5	184.0	208.0	15.11	8.05	75.37	11.509	1.129	1/2	8431	4.8	15380	395	455	200	277	270	395	250	300/350	300	350/410	---	360	---	215	
TDP8-9011	100	191	254	1800	3580	700	45	375.2	179.6	202.4	16.06	11.76	79.83	16.14	1.584	1/2	6401	5.2	16090	428	492	230	313	290	435	250	300/350	300	350/410	---	360	---	215	
TDP8-9015	140	300	400	1200	3200	1200	100	536.0	185.9	241.8	20.67	20.53	104.37	26.183	2.57	1/2	6357	5.5	19330	478	548	250	346	315	475	250	350/410	350	410/470	---	425	---	255	
TDP8-9021	200	337	448	---	3000	1200	100	719.5	212.8	269.9	23.83	33.78	132.80	43.682	4.29	1/2	7386	6	23110	532	602	290	393	350	525	300	350/410	410	470	---	475	---	255	
TDP8-9026	250	503	669	---	3000	1900	100	969.3	248.5	279.5	33.82	65.84	168.95	70.033	6.87	1/2	8478	7	27310	592	662	320	439	390	585	350	410/470	410	470	---	535	---	290	
TDP10-5300	50	119	159	1800	4500	350	45	197.1	143.6	168.7	10.27	3.94	47.27	6.13	0.60	1/4	9547	2.8	8750	340	404	180	249	230	345	200	250/300	250	300/350	---	300	---	175	
TDP10-8400	80	159	212	1800	4250	500	45	233.6	154.3	176.2	14.64	5.22	58.69	8.485	0.83	1/4	13740	3	13630	364	425	190	264	245	365	210	250/300	250	350/410	---	307	---	197	
TDP10-9011	100	220	293	1200	3880	700	45	312.6	186.3	208.5	20.83	8.15	75.37	11.509	1.13	1/4	30120	3.3	17810	395	455	200	277	270	395	250	300/350	300	350/410	---	360	---	215	
TDP10-9013	125	246	327	1200	3580	700	45	380.0	181.5	204.0	26.24	11.95	79.83	16.144	1.58	1/4	26750	3.7	18970	428	492	230	313	290	435	250	300/350	300	350/410	---	360	---	215	
TDP10-9019	180	387	515	1200	3200	1200	100	537.5	188.9	242.6	36.47	20.65	104.37	26.18	2.57	1/4	29000	4.2	25290	478	548	250	346	315	475	250	350/410	350	410/470	---	425	---	255	
TDP10-9023	224	433	576	---	3000	1200	100	722.7	216.0	270.8	45.84	34.11	132.80	43.68	4.29	1/4	33400	5	28300	532	602	290	393	350	525	300	350/410	410	470	---	475	---	255	
TDP10-9033	315	647	861	---	3000	1900	100	980.7	252.5	282.0	63.92	56.71	168.95	70.03	6.87	1/4	37650	5.8	37500	592	662	320	439	390	585	350	410/470	410	470	---	535	---	290	

TDA Series

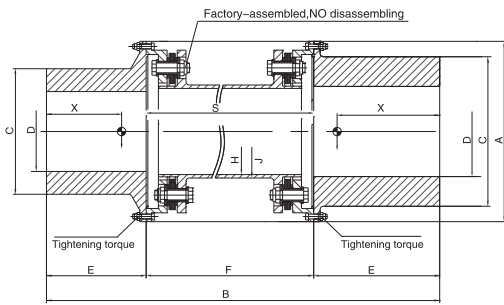

- Meeting requirements in API610 or API671, suitable for refinery, chemical engineering processing pumps and other middle/low speed applications as required in accordance with the standards.
- Factory-assembled middle transmitting unit, dynamic balance well kept and easy mounting/dismounting.
- Designed for big hub, relatively bigger allowable shaft diameter.

Direction for use

- Bore diameter D, hub outside diameter C, hub length E, distance between flange mating faces F may be designed separately according to the matching requirements of the machines.
- Based on the needs the connection between the driving and driven machines may be designed with taper bored hub (with or without key), expansion sleeve, flange, spline, etc. For straight bore connection to be applied the hub-shaft fit types list in the table are recommended.

Fit type	Bore tolerance for hub	Recommendation for shaft tolerance	Mounting method
Clearance fit, with single or double key connection	F7	h6	Cold mounting, with a setscrew on the keyway top
Transition fit, with single or double key connection	H7	k6 m6 n6	Hot mounting
		r6 s6 t6 u6	Hot mounting
Interference fit, with single or double key connection	P7	h6	Hot mounting

- In the catalogue the total weight, centre of gravity, torsional stiffness and moment of inertia are calculated according to max. allowable bore diameter, max. hub outside diameter and standard distance between flange mating faces. For other sizes of bore diameter, hub outside diameter and distance between flange mating faces, above mentioned parameters should be calculated or corrected separately, where the torsional stiffness is taken in the fitting section of the shaft. For various distances between flange mating faces the torsional stiffness K can be calculated using the formula as follows:

$$\frac{1}{K} = \frac{1}{K_T} + \frac{\Delta L}{\Delta K_T}$$

Where K- torsional stiffness for a given distance between flange mating faces, K_T- torsional stiffness shown in the catalogue, ΔK_T- torsional stiffness for spacer tube per meter as shown in the catalogue, ΔL- variation of size F relative to TRUMY recommended minimum distance between flange mating faces.

- According to API610 distance between flange mating faces F shall not be less than 125mm (5in) ; and according to section 8.3, API671(4-th edition), unless otherwise the purchaser requires, F shall be the value corresponding to distance between the shaft ends 460mm (18in) . The standard distances between flange mating faces F listed in this catalogue are in accordance with section 8.3, API671(4-th edition). The "minimum" distance between flange mating faces F is referred to as the shortest distance between flange mating faces which meets the conditions of part machining technology and installing space for the structure. The "minimum" distance configuration shall not be selected as far as possible. If shorter distances are needed, please consult TRUMY sales engineer. (Note: in part of the design programs the distance between flange mating faces F is not consistent with the distance between the shaft ends.)
- Peak torque rating is the max. torque the coupling can tolerate for short period. Momentary torque limit is the torque that corresponds to a factor of safety of 1.0 with respect to the most highly stressed component's material yield strength, allowing for a combination of speed, angular misalignment and axial displacement.
- If you have any questions or any other particular requirements, please consult TRUMY sales engineer.

Coupling capacity and main dimentions & Tecndal Data

Type	Continuos Torque Rating (KNm)	Peak Torque ⁽⁵⁾ (KNm)	Max Momentary Torque ⁽⁵⁾ (KNm)	Max Speed (r/min)	A (mm)	B (mm)	C ⁽¹⁾ (mm)	D ⁽¹⁾ (mm)	E ⁽¹⁾ (mm)	F ⁽¹⁾⁽⁴⁾ (mm)		H (mm)	J (mm)
										std	min		
TDA6-66	0.63	1.7	2.3	21800	127	230	89	60	65	460	100	47	55
TDA6-150	1.4	3.2	4.2	19500	146	272	105	70	75	460	122	47	65
TDA6-180	1.8	3.8	5.1	16600	168	290	127	85	90	460	110	69	82
TDA6-330	3.15	8.7	11.6	14300	188	340	150	100	105	460	130	83	94
TDA6-580	5.6	14.8	19.7	12600	212	400	175	115	120	460	160	91	105
TDA6-840	8	16.8	22.4	11000	236	430	195	130	135	460	160	110	125
TDA6-1300	12.5	27.1	36	9500	272	525	225	150	165	460	195	116	133
TDA6-1800	18	39.7	52.8	8800	300	545	250	170	180	460	185	133	153
TDA6-2600	25	51.3	68.3	8000	316	590	270	185	195	460	200	143	162
TDA8-2900	28	67.1	89.3	8800	305	675	260	175	185	460	305	142	164
TDA8-4200	40	78.2	104	7500	348	715	290	195	205	460	305	158	181
TDA8-5900	56	116	155	6500	404	730	345	230	240	460	250	202	224
TDA8-8400	80	162	215	6100	425	780	365	245	255	500	270	216	242
TDA8-9013	125	242	322	5600	455	885	395	270	290	500	305	224	256
TDA8-9015	140	269	358	5100	492	925	435	290	310	500	305	264	292
TDA8-9021	200	404	537	4600	548	1000	475	315	335	550	330	294	327

Type	Tightening Torque(Nm)	Weight of Total Coupling ⁽³⁾ (Kg)	Centre of Gravity x ⁽³⁾ (mm)	Torsional Stiffness K _T ⁽³⁾ (MNm/Rad)	Moment of Inertia I ⁽³⁾ (Kg ^m ²)	Spacer Tube Per m			Angular Misalignment		Axial Displacement	
						Weight (Kg)	Torsional Stiffness ΔK _T (MNm/Rad)	Moment of Inertia (Kg ^m ²)	Max (deg)	Restoring Moment (Nm/deg)	Max (± mm)	Axial Force(N)
TDA6-66	15	9.2	64.2	0.040	0.015	5.03	0.0335	0.0033	2/3	106.3	1.1	370
TDA6-150	15	15.2	73.2	0.106	0.030	12.43	0.102	0.010		200.8	1.5	840
TDA6-180	15	20.5	78.1	0.119	0.060	12.10	0.177	0.017		114.5	1.8	840
TDA6-330	25	28.2	84.3	0.209	0.112	12.00	0.240	0.024		221.1	2	1290
TDA6-580	45	44.3	97.1	0.453	0.231	16.92	0.416	0.041		286.2	2.2	1950
TDA6-840	45	58.2	107.0	0.500	0.39	21.73	0.768	0.075		256.4	2.5	2360
TDA6-1300	100	91.4	128.2	0.807	0.82	26.10	1.035	0.102		240.6	3	3270
TDA6-1800	150	116.2	135.8	1.282	1.27	35.26	1.846	0.181		566.9	3.3	4260
TDA6-2600	180	141.2	145.5	1.588	1.80	35.73	2.125	0.209	552.9	3.4	5090	
TDA8-2900	180	130.2	140.0	2.895	1.51	41.50	2.488	0.244	1/2	1879	2.2	6080
TDA8-4200	180	179.8	152.7	3.215	2.72	48.07	3.535	0.347		1421	2.8	7560
TDA8-5900	350	280.0	171.4	5.276	5.96	57.58	6.697	0.657		2311	3.2	8530
TDA8-8400	500	338.4	186.5	8.951	8.00	73.42	9.840	0.966		4194	3.5	12010
TDA8-9013	700	438.8	213.4	13.437	12.17	94.70	13.959	1.369		9319	3.7	18520
TDA8-9015	700	555.2	216.4	14.116	18.70	95.98	18.947	1.859		6401	4	17330
TDA8-9021	1200	744.0	237.3	21.416	30.23	126.34	31.121	3.054		7265	4.5	22600

TDP-T Series

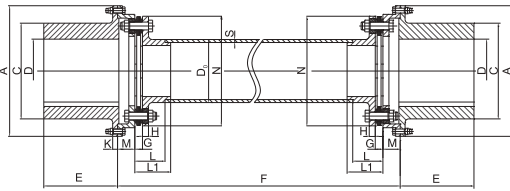

TDP-TZ Series

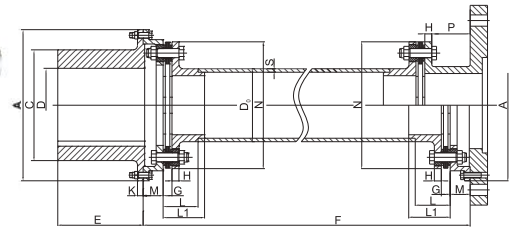

- ◆ Suitable for applications of ultra distance between the shaft ends
- ◆ In most cases big length spacer solutions shall be tailored to customer particular requirements, so that please contact TRUMY sales engineer as soon as possible on the product primary design stage in order to obtain best effect of the design.

Direction for use

- Bore diameter D, hub outside diameter C, hub length E, distance between flange mating faces F may be designed separately according to the matching requirements of the machines.
- Based on the needs the connection between the driving and driven machines may be designed with taper bored hub (with or without key), expansion sleeve, flange, spline, etc. For straight bore connection to be applied the hub-shaft fit types list in the table are recommended.
- The tubing specifications chosen shall ensure the floating section with the critical rotation speed far apart from any operating speeds for enough safety margin, which shall be determined through calculation based on operating speeds and distance between flange mating surfaces.
- Peak torque rating is the max. torque the coupling can tolerate for short period. Momentary torque limit is the torque that corresponds to a factor of safety of 1.0 with respect to the most highly stressed component's material yield strength, allowing for a combination of speed, angular misalignment and axial displacement.
- If you have any questions or any other particular requirements, please consult TRUMY sales engineer.

Fit type	Bore tolerance for hub	Recommendation for shaft tolerance	Mounting method
Clearance fit, with single or double key connection	F7	h6	Cold mounting, with a setscrew on the keyway top
Transition fit, with single or double key connection	H7	k6 n6 n6	Hot mounting
		r6 s6 t6 u6	Hot mounting
Interference fit, with single or double key connection	P7	h6	Hot mounting

Coupling capacity and main dimensions (mm)

Type	Continuous Torque Rating (KNm)	Peak Torque Rating ⁽⁴⁾ (KNm)	Momentary Torque Limit ⁽⁴⁾ (KNm)	Angular Misalignment		Axial Displacement		A	C ⁽¹⁾ (max)	D ⁽¹⁾ (max)	L1	L	E ⁽¹⁾	G	H	M	K	N	P
				Max (deg)	Restoring Moment (Nm/deg)	Max (± mm)	Axial Force (N)												
TDP6-1300T	10	19.4	22.4	2/3	526.4	3.6	2580	300	248	170	60	40	190	17.4	15	43	16	250	85
TDP6-2100T	16	27.7	31.9	2/3	435.6	3.8	3640	316	270	185	60	40	205	20.4	16	46	16	276	90
TDP8-3300T	25	40.0	46.1	1/2	1130	3	5060	348	286	200	85	60	220	20.4	21	46	20	292	90
TDP8-4200T	31	46.3	53.3	1/2	1999	3.8	5700	404	338	230	85	60	255	22.8	22	50	20	340	105
TDP8-6600T	50	72.8	83.7	1/2	3338	4.2	9010	425	360	245	85	60	270	27.6	24	57	20	364	120
TDP8-8400T	63	93.1	107.1	1/2	8431	4.8	12110	455	390	270	100	70	300	33	25	60	20	395	130
TDP8-9011T	80	118.1	135.9	1/2	6401	5.2	12870	492	420	290	100	70	320	33	25	60	20	428	130
TDP8-9015T	112	165.6	190.5	1/2	6357	5.5	15460	548	460	315	120	85	320	34	33	75	25	478	155
TDP8-9021T	160	236.0	271.5	1/2	7386	6	18490	602	512	350	120	85	350	34	33	75	25	532	155
TDP8-9026T	200	295.6	340	1/2	8478	7	21850	662	570	390	140	95	390	38.6	38	85	25	592	180
TDP10-9033T	250	369.5	425	1/4	37650	5.8	29760	662	570	390	140	95	390	41.6	35	85	25	592	180
TDP10-9042T	315	465	535	1/4	42000	6	34360	692	590	415	140	95	415	45	38	85	25	622	200

Steel tube materials and specifications (mm)

Type	Do × S							
	Material: 20		Material: 16Mn					
TDP6-1300T	159 × 4.5,	152 × 5,	146 × 6	140 × 7				
TDP6-2100T	180 × 6,	168 × 6,	159 × 6	159 × 5,	146 × 8			
TDP8-3300T	194 × 6,	180 × 7,	168 × 10	180 × 6,	168 × 8,	168 × 7,	159 × 8	
TDP8-4200T	219 × 6,	203 × 8,	194 × 8	194 × 6,	180 × 8,	168 × 8,	159 × 10	
TDP8-6600T	245 × 8,	219 × 10,	203 × 12	245 × 6.5,	219 × 8,	203 × 10,	194 × 10,	180 × 12
TDP8-8400T	245 × 10,	219 × 14,	203 × 16	245 × 8,	219 × 10,	203 × 14,	203 × 10,	194 × 12
TDP8-9011T	273 × 10,	245 × 14,	219 × 16	273 × 10,	245 × 10,	219 × 14,	219 × 12	
TDP8-9015T	325 × 10,	299 × 12,	273 × 14	325 × 9,	299 × 10,	273 × 12,	273 × 10	
TDP8-9021T	351 × 12,	325 × 16		351 × 10,	325 × 14,	325 × 12,	299 × 12	
TDP8-9026T	402 × 12,	377 × 14		325 × 14,	299 × 16			
TDP10-9033T	402 × 16,	377 × 18		356 × 14,	351 × 14			
TDP10-9042T	426 × 16			402 × 16				

D-X1 Series couplings dedicated to cooling water towers

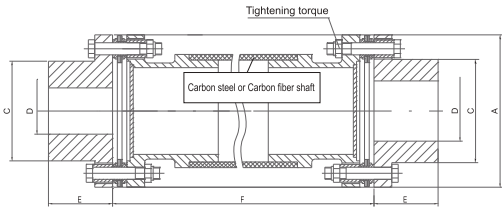

- ◆ The series is dedicated to intensive corrosion environment applications, e. x. cooling water towers. Coupling fasteners are made from stainless steel and big size parts are protected with a corrosion resistant coating.
- ◆ The spacer may be also made from carbon fiber , a corrosion resistant and lighter weight material.
- ◆ If needed, the big size parts of the series may have stainless steel structure to meet Requirements for corrosion resistance.

Direction for use

1. Bore diameter D, hub outside diameter C, hub length E, distance between flange mating faces F may be designed separately according to the matching requirements of the machines.
2. Based on the needs the connection between the driving and driven machines may be designed with taper bored hub (with or without key), expansion sleeve, flange, spline, etc. For straight bore connection to be applied the hub-shaft fit types list in the table are recommended.

Fit type	Bore tolerance for hub	Recommendation for shaft tolerance	Mounting method
Clearance fit, with single or double key connection	F7	h6	Cold mounting, with a setscrew on the keyway top
Transition fit, with single or double key connection	H7	k6 m6 n6	Hot mounting
		r6 s6 t6 u6	Hot mounting
Interference fit, with single or double key connection	P7	h6	Hot mounting

3. Peak torque rating is the max. torque the coupling can tolerate for short period. Momentary torque limit is the torque that corresponds to a factor of safety of 1.0 with respect to the most highly stressed component's material yield strength, allowing for a combination of speed, angular misalignment and axial displacement.
4. If you have any questions or any other particular requirements, please consult TRUMY sales engineer.

Coupling capacity and main dimensions

Dimension Unit: mm

Type	Continuous Torque Rating(KNm)	Peak Torque (KNm)	Momentary Torque (KNm)	Angular Misalignment (deg)	Axial Displacement (± mm)	A (mm)	C ⁽¹⁾ (mm) Max	D ⁽¹⁾ (mm) Max	E ⁽¹⁾ (mm)	G (mm)	Tightening Torque (Nm)
D6-220X1	1.6	3.6	4.8	2/3	2	236	92	62	90	169	45
D8-440X1	3.15	7.1	9.45	1/2	3	280	130	90	110	214	70

Max. allowable distance between flange mating faces Fmax (mm) for different rotation speeds

Type	1500 (r/min)	1000 (r/min)	750 (r/min)	500 (r/min)
D6-220X1	3350	4100	4750	5800
D8-440X1	4200	4850	5500	6600

Description of compensating capability, axial force and angular bending moment

Transmitting torque and motion, the coupling in operation has to endure angular and radial misalignments and axial displacement simultaneously, as shown in the figure. The capability for compensating radial misalignment, a function of angular deformation and distance between the ends of shafts, is usually realized by angular deformation of the flexible elements. Deformations of the coupling, when in operation, should not beyond the range of permissible misalignments.

The flexible elements with axial deformation will generate axial bounce force (axial force), while angular deformation will lead to angular bounce moment (angular bending moment). The relation between axial force, angular bending moment and deformation is illustrated as follows:

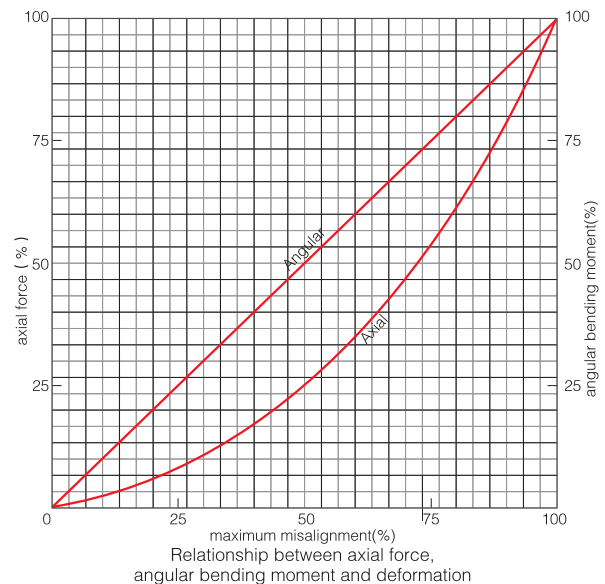
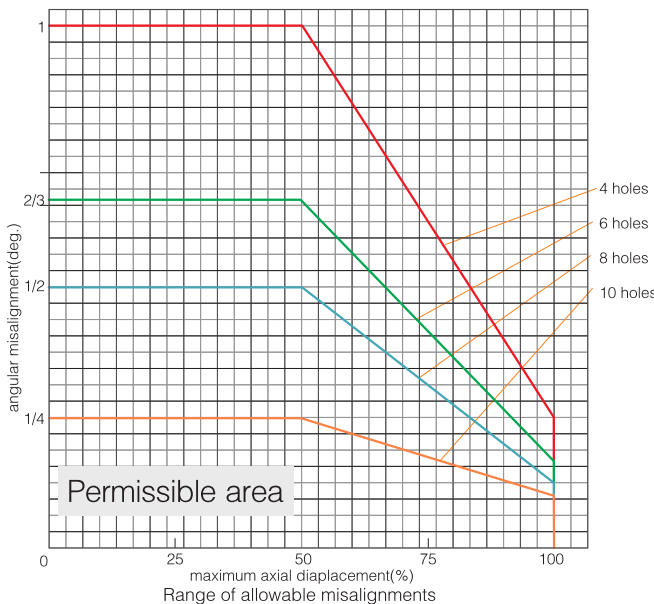

Description of dynamic balancing

- ◆ Owing to precise positioning of coupling parts in design and precise machining, TRUMY couplings have been well balanced. The coupling parts should be carefully handled in processes of storage, transportation and installation in order to ensure high dynamic balancing quality.
- ◆ On the basis of the concrete coupling design and working conditions our company can conduct coupling balancing according either to the company norms or to the procedures corresponding to the standard API 671 alternatively.
- ◆ The potential balance precision of TRUMY couplings is up to the standard AGMA 9000-C90 8. The maximum allowable speed values listed in the catalogue are company guided ones on the basis of grade 8 AGMA. If a higher speed is needed, please select TRUMY high speed high performance flexible disc coupling or flexible diaphragm coupling, or otherwise consult with the sales engineer of our company.

Specialized design to meet customer particular requirements

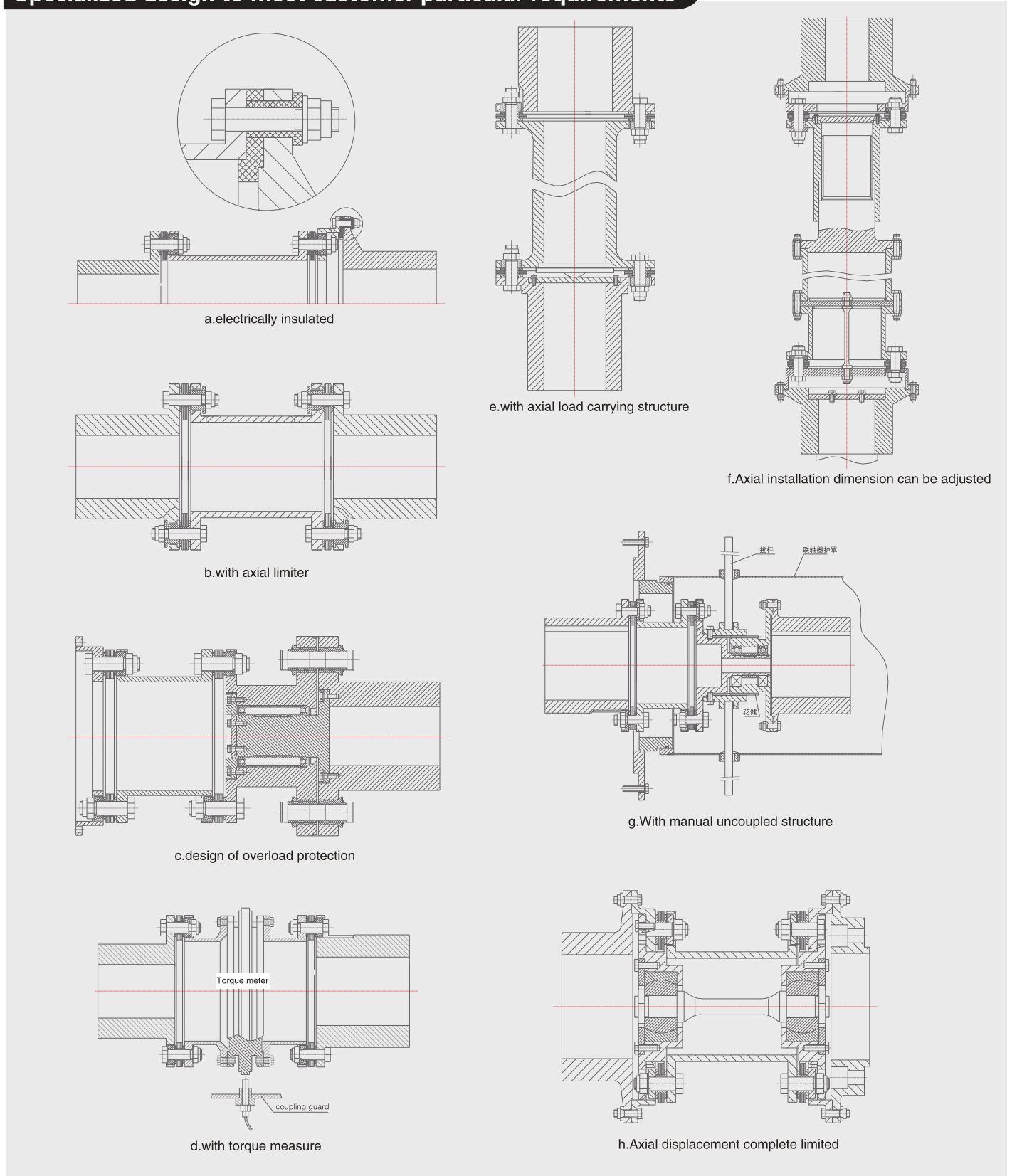



- ◆ For all kinds of turbine compressor sets and the equipment driven by steam turbines, gas turbines and all kinds of energy recovery turbines TRUMY high speed–high performance flexible disc or diaphragm coupling series are your first choice among power transmitting coupling products.
- ◆ For some low speed applications TRUMY grid coupling series may be selected.



无锡创明传动工程有限公司
WUXI TRUMY TRANSMISSION ENGINEERING CO.,LTD.

Add: No.8, Huayou Rd.,New District,Wuxi,China
Tel: 86-510-85701227 85701931
85709703 85251719 85251729
P.C.: 214142
Fax: 86-510-85706330
Http: www.trumy.com
E-mail: trumy@trumy.com